

IR Receiver Modules for 3D Synchronization Signals

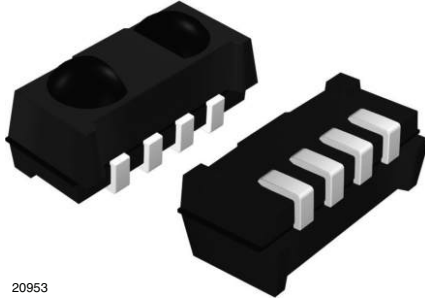

20953

MECHANICAL DATA

Pinning:

 1, 4 = GND, 2 = V_S , 3 = OUT

FEATURES

- Center frequency at 25 kHz to reduce interference with IR remote control signals at 30 kHz to 56 kHz
- Package can be used with IR emitters with wavelength 830 nm as well as standard 940 nm
- Very low supply current and stand-by mode
- Photo detector and preamplifier in one package
- Internal filter for PCM frequency
- Supply voltage range: 2.5 V to 5.5 V
- Improved immunity against modulated light sources
- Insensitive to supply voltage ripple and noise
- Taping available for topview and sideview assembly
- Compliant to RoHS directive 2002/95/EC and in accordance to WEEE 2002/96/EC

RoHS
COMPLIANT

DESCRIPTION

The TSOP75D25 is an SMD IR receiver module for 3D synchronisation signals. The receiver is designed to operate at a carrier frequency of 25 kHz and a wavelength of 830 nm to avoid interference with standard remote control systems at 940 nm and 30 kHz to 56 kHz. The TSOP75D25 can receive continuously transmitted signal patterns with a minimum burst length of 6 cycles and frame rates up to 200 Hz. The circuit provides good suppression of optical noise from CFLs, LCD backlight and plasma panels.

PARTS TABLE

CARRIER FREQUENCY	GOOD NOISE SUPPRESSION AND FAST BURST RATE
25 kHz	TSOP75D25

BLOCK DIAGRAM

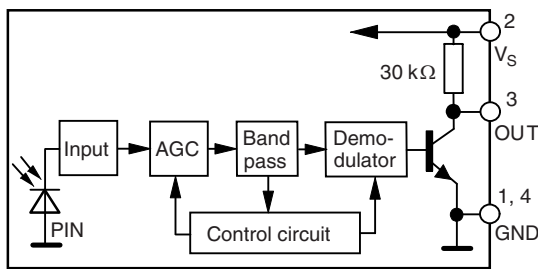

20445-1

APPLICATION CIRCUIT

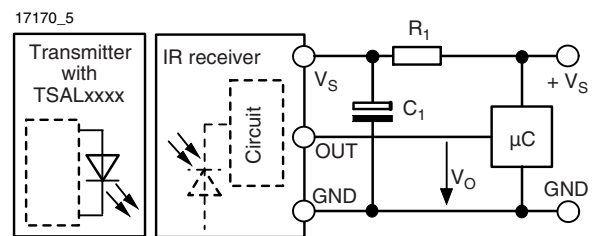

R_1 and C_1 are recommended for protection against EOS. Components should be in the range of $33 \Omega < R_1 < 1 \text{ k}\Omega$, $C_1 > 0.1 \mu\text{F}$.

ABSOLUTE MAXIMUM RATINGS				
PARAMETER	TEST CONDITION	SYMBOL	VALUE	UNIT
Supply voltage (pin 2)		V_S	- 0.3 to + 6	V
Supply current (pin 2)		I_S	3	mA
Output voltage (pin 3)		V_O	- 0.3 to ($V_S + 0.3$)	V
Output current (pin 3)		I_O	5	mA
Junction temperature		T_j	100	°C
Storage temperature range		T_{stg}	- 25 to + 85	°C
Operating temperature range		T_{amb}	- 25 to + 85	°C
Power consumption	$T_{amb} \leq 85 \text{ °C}$	P_{tot}	10	mW

Note

- Stresses beyond those listed under “Absolute Maximum Ratings” may cause permanent damage to the device. This is a stress rating only and functional operation of the device at these or any other conditions beyond those indicated in the operational sections of this specification is not implied. Exposure to absolute maximum rating conditions for extended periods may affect the device reliability.

ELECTRICAL AND OPTICAL CHARACTERISTICS ($T_{amb} = 25 \text{ °C}$, unless otherwise specified)						
PARAMETER	TEST CONDITION	SYMBOL	MIN.	TYP.	MAX.	UNIT
Supply current (pin 2)	$E_v = 0, V_S = 3.3 \text{ V}$	I_{SD}	0.27	0.35	0.45	mA
	$E_v = 40 \text{ klx, sunlight}$	I_{SH}		0.45		mA
Supply voltage		V_S	2.5		5.5	V
Transmission distance	$E_v = 0$, test signal see fig. 1, IR diode TSAL6200, $I_F = 250 \text{ mA}$	d		45		m
Output voltage low (pin 3)	$I_{OSL} = 0.5 \text{ mA}$, $E_e = 0.7 \text{ mW/m}^2$, test signal see fig. 1	V_{OSL}			100	mV
Minimum irradiance	Pulse width tolerance: $t_{pi} - 80 \mu\text{s} < t_{po} < t_{pi} + 160 \mu\text{s}$, test signal see fig. 1	$E_e \text{ min.}$		0.15	0.35	mW/m^2
Maximum irradiance	$t_{pi} - 80 \mu\text{s} < t_{po} < t_{pi} + 160 \mu\text{s}$, test signal see fig. 1	$E_e \text{ max.}$	30			W/m^2
Directivity	Angle of half transmission distance	$\phi_{1/2}$		± 50		deg

TYPICAL CHARACTERISTICS ($T_{amb} = 25 \text{ °C}$, unless otherwise specified)

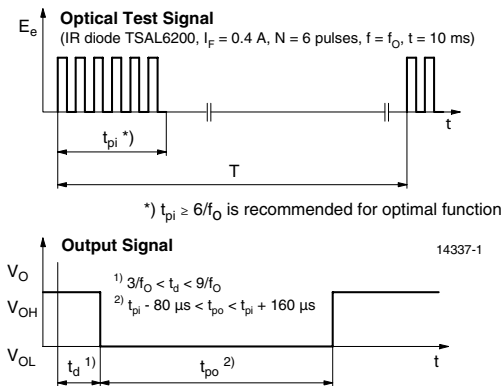

Fig. 1 - Output Active Low

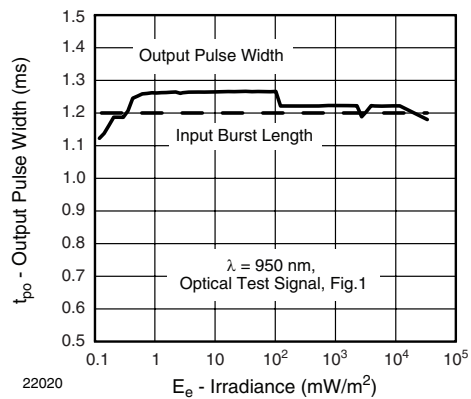

Fig. 2 - Pulse Length and Sensitivity in Dark Ambient

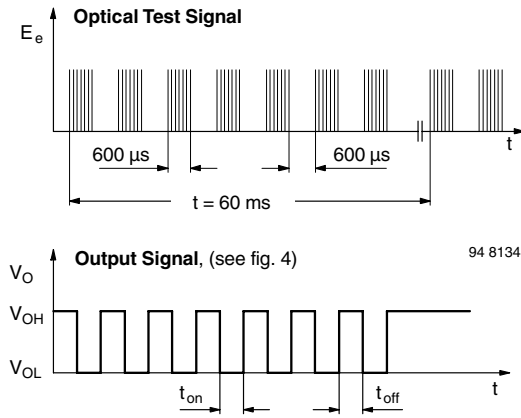

Fig. 3 - Output Function

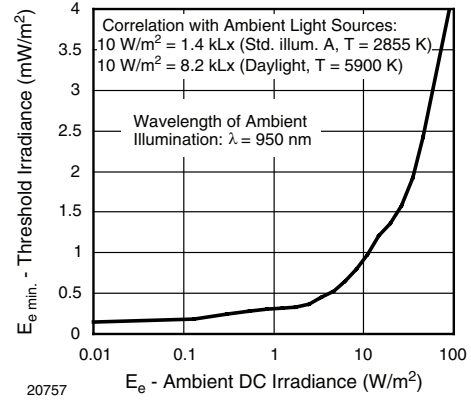

Fig. 6 - Sensitivity in Bright Ambient

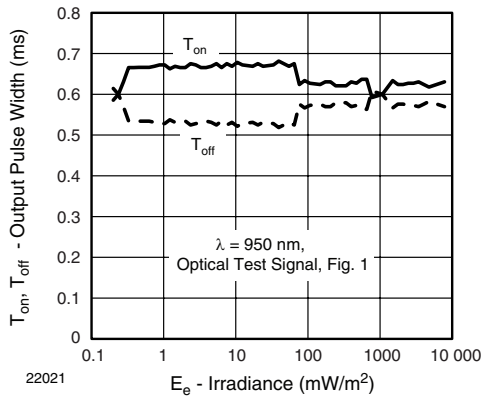

Fig. 4 - Output Pulse Diagram

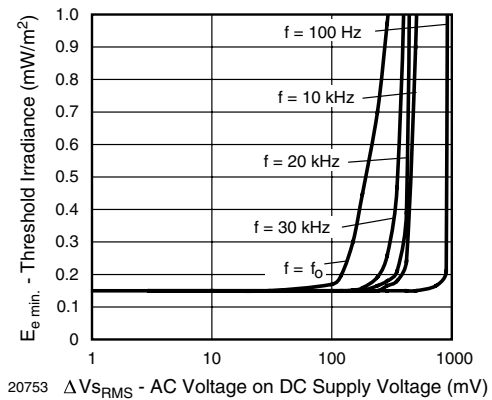

Fig. 7 - Sensitivity vs. Supply Voltage Disturbances

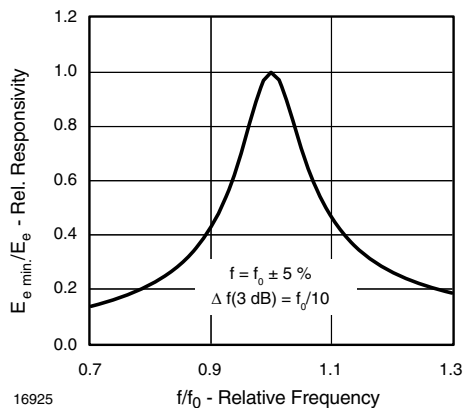

Fig. 5 - Frequency Dependence of Responsivity

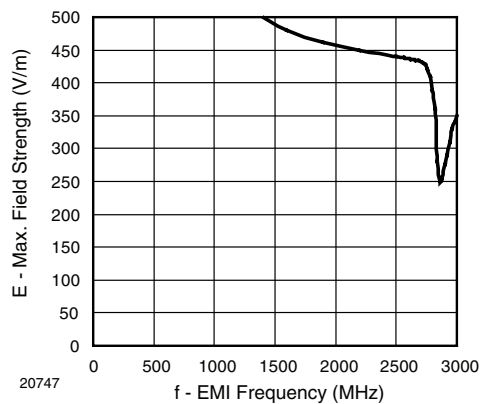

Fig. 8 - Sensitivity vs. Electric Field Disturbances

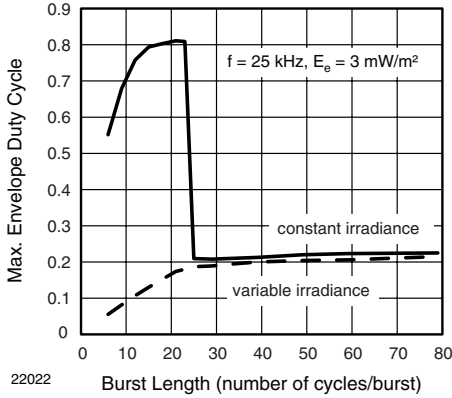

Fig. 9 - Maximum Envelope Duty Cycle vs. Burst Length

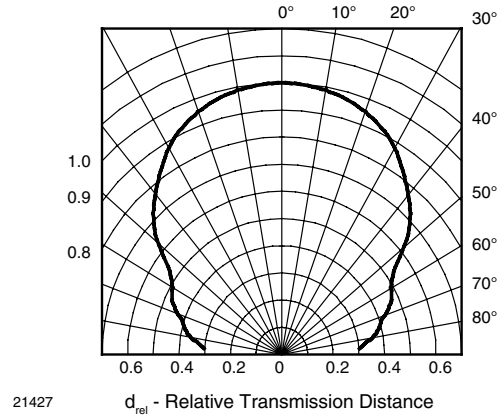

Fig. 12 - Horizontal Directivity

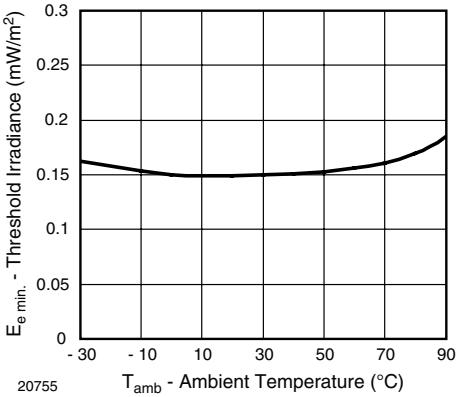

Fig. 10 - Sensitivity vs. Ambient Temperature

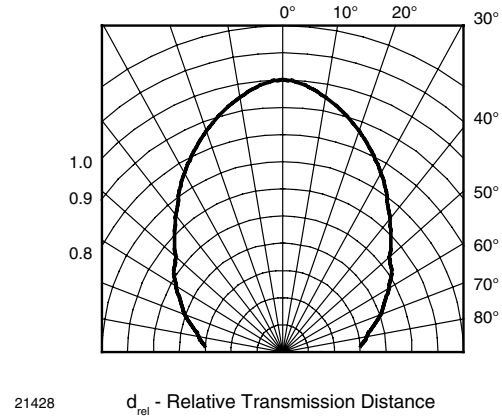

Fig. 13 - Vertical Directivity

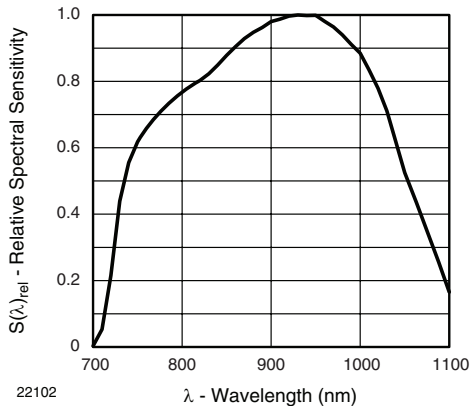

Fig. 11 - Relative Spectral Sensitivity vs. Wavelength

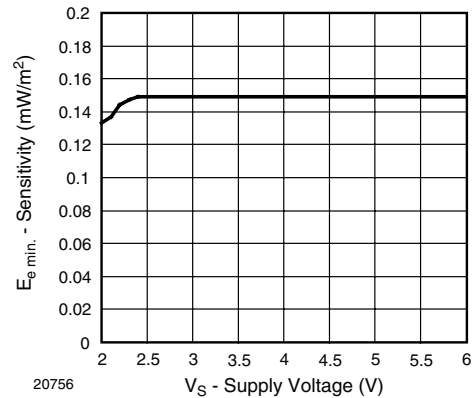

Fig. 14 - Sensitivity vs. Supply Voltage

SUITABLE DATA FORMAT

The TSOP75D25 is designed to suppress spurious output pulses due to noise or disturbance signals. Data and disturbance signals can be distinguished by the devices according to carrier frequency, burst length and envelope duty cycle. The data signal should be close to the band-pass center frequency (e.g. 25 kHz) and fulfill the conditions in the table below.

When a data signal is applied to the TSOP75D25 in the presence of a disturbance signal, the sensitivity of the receiver is reduced to insure that no spurious pulses are present at the output. Some examples of disturbance signals which are suppressed are

- DC light (e.g. from tungsten bulb or sunlight)
- Continuous signals at any frequency
- Strongly or weakly modulated noise from fluorescent lamps with electronic ballasts (see figure 15 or figure 16)

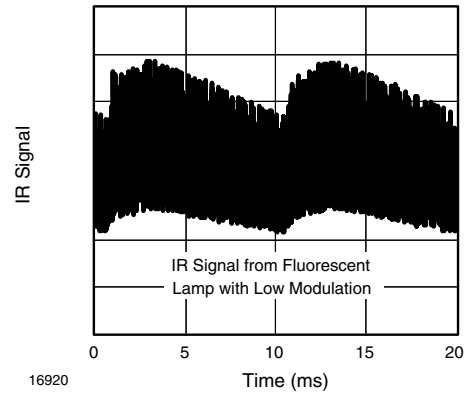

Fig. 15 - IR Signal from Fluorescent Lamp with Low Modulation

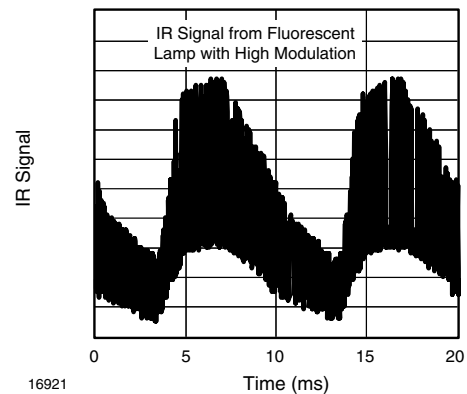

Fig. 16 - IR Signal from Fluorescent Lamp with High Modulation

	TSOP75D25
Minimum burst length	6 cycles/burst
After each burst of length a minimum gap time is required of	6 to 24 cycles ≥ 6 cycles
For bursts greater than a minimum gap time in the data stream is needed of	24 cycles > 4 x burst length
Maximum rate of short bursts (constant irradiance)	2000 bursts/s
Maximum rate of short bursts (variable irradiance)	220 bursts/s

STAND-BY MODE OF THE TSOP75D25

If an application requires an ultra low average supply current in order to save battery life, the TSOP75D25 can be operated with an intermittent supply voltage. A typical application circuit shown in fig. 17.

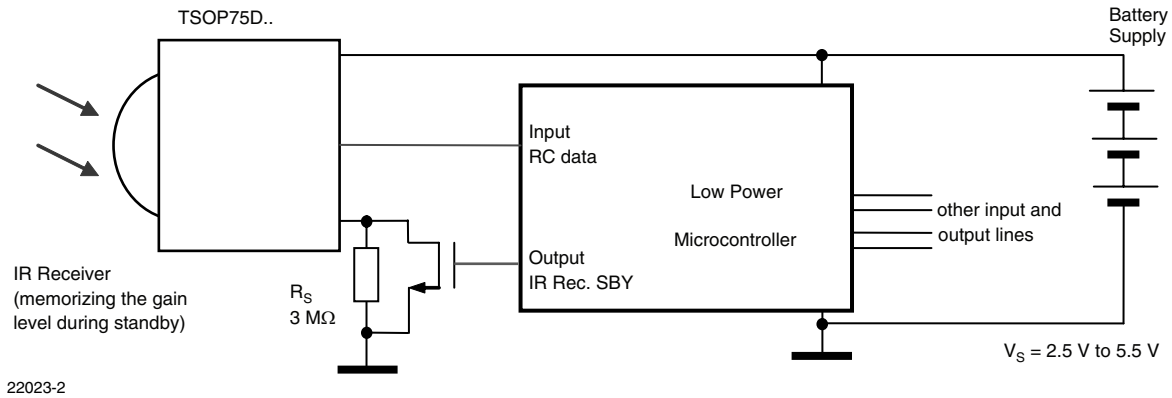

Fig. 17 - Application Circuit for the TSOP75D25 with Intermittent Supply Voltage

To receive a continuous data signal while using the TSOP75D25 with an intermittent supply voltage, the receiver must be activated in advance of the expected data frame as shown in figure 18.

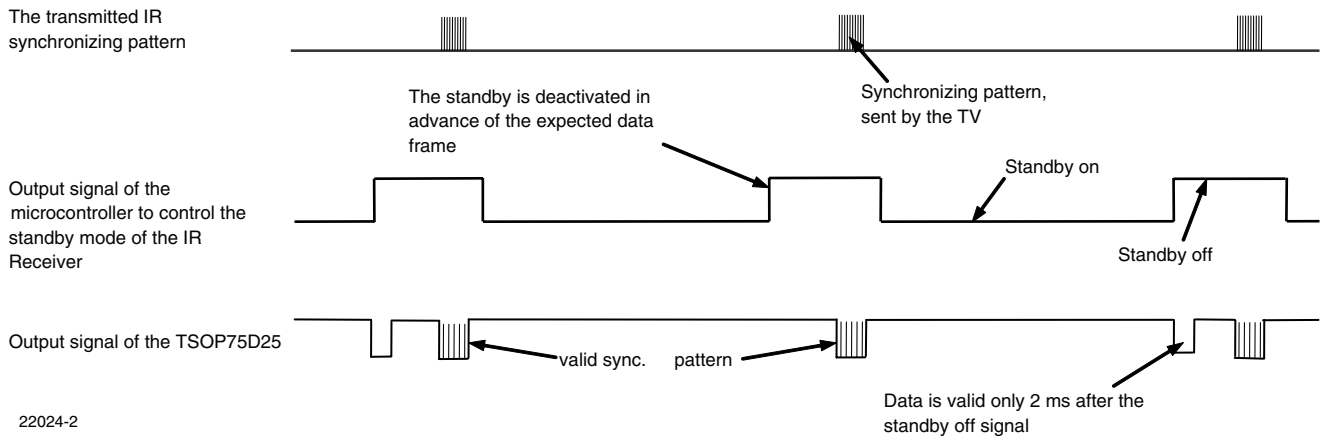

Fig. 18 - Signal Timing in Power Saving Mode with Continuous Receiving Function

In normal operation without using the stand-by feature, the gain level of the TSOP75D25 returns to a default level after the device is disconnected from supply voltage and reconnected again. A settling time of up to 100 ms is necessary until the gain has settled to an optimum level that is well matched to the ambient noise level.

Using the device in stand-by mode, the TSOP75D25 memorizes its gain setting while in standby. On re-activation, the gain immediately returns to the correct level present before stand-by. This operation insures that there are no spurious pulses on power-up due to mismatch between the gain level and the ambient light conditions.

ELECTRICAL AND OPTICAL CHARACTERISTICS ($T_{amb} = 25\text{ }^{\circ}\text{C}$, unless otherwise specified)						
PARAMETER	TEST CONDITION	SYMBOL	MIN.	TYP.	MAX.	UNIT
Serial resistor to activate the standby mode	$V_S = 3\text{ V}$	R_S	1.2	1.5	2	$M\Omega$
	$V_S = 5\text{ V}$	R_S	2	3	4	
Standby supply current	$V_S = 3\text{ V}$, $R_S = 1.5\text{ M}\Omega$	I_{SBY}	1	1.4	2	μA
	$V_S = 5\text{ V}$, $R_S = 3\text{ M}\Omega$	I_{SBY}	1	1.4	2	
Latency time for standby-off (delay until there is a valid response)	$V_S > 2.5\text{ V}$, dark ambient, output is valid	t_{delay}		0.4	0.8	ms
	$V_S > 2.5\text{ V}$, 10 kLux daylight, output is valid	t_{delay}		1.5	2.5	
Duration of standby-off period	$V_S > 2.5\text{ V}$, dark ambient	t_{SBY_OFF}	1			ms
	$V_S > 2.5\text{ V}$, 10 kLux daylight, AGC1 or AGC3 device	t_{SBY_OFF}	4			
	$V_S > 2.5\text{ V}$, 10 kLux daylight, AGC2 or AGC4 device	t_{SBY_OFF}	3			

TYPICAL CHARACTERISTICS ($T_{amb} = 25\text{ }^{\circ}\text{C}$, unless otherwise specified)

Fig. 1 - Delay Time after Standby-off until the TSOP75D25 is ready to receive Data

PACKAGE DIMENSIONS in millimeters

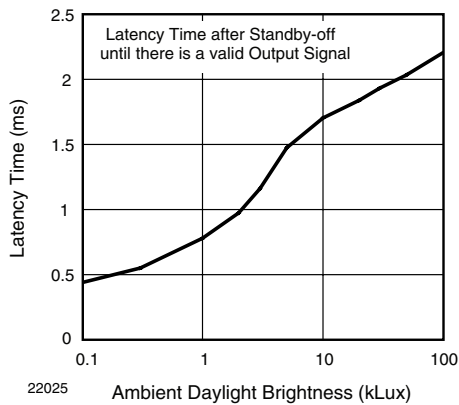
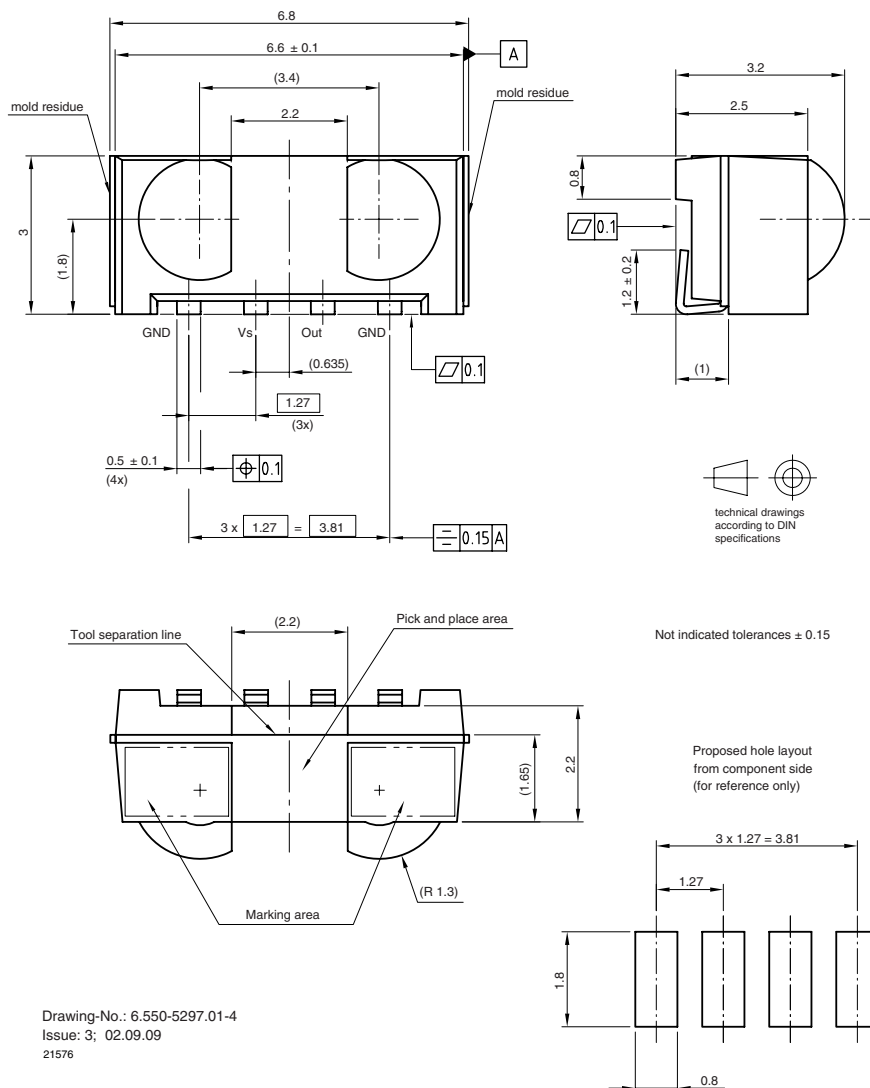

Drawing-No.: 6.550-5297.01-4
 Issue: 3; 02.09.09
 21576

ASSEMBLY INSTRUCTIONS

Reflow Soldering

- Reflow soldering must be done within 72 h while stored under a max. temperature of 30 °C, 60 % RH after opening the dry pack envelope
- Set the furnace temperatures for pre-heating and heating in accordance with the reflow temperature profile as shown in the diagram. Exercise extreme care to keep the maximum temperature below 260 °C. The temperature shown in the profile means the temperature at the device surface. Since there is a temperature difference between the component and the circuit board, it should be verified that the temperature of the device is accurately being measured
- Handling after reflow should be done only after the work surface has been cooled off

Manual Soldering

- Use a soldering iron of 25 W or less. Adjust the temperature of the soldering iron below 300 °C
- Finish soldering within 3 s
- Handle products only after the temperature has cooled off

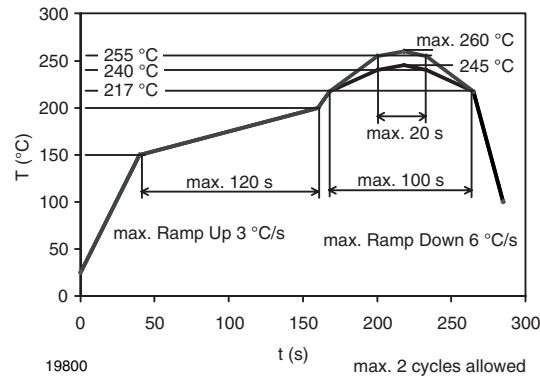
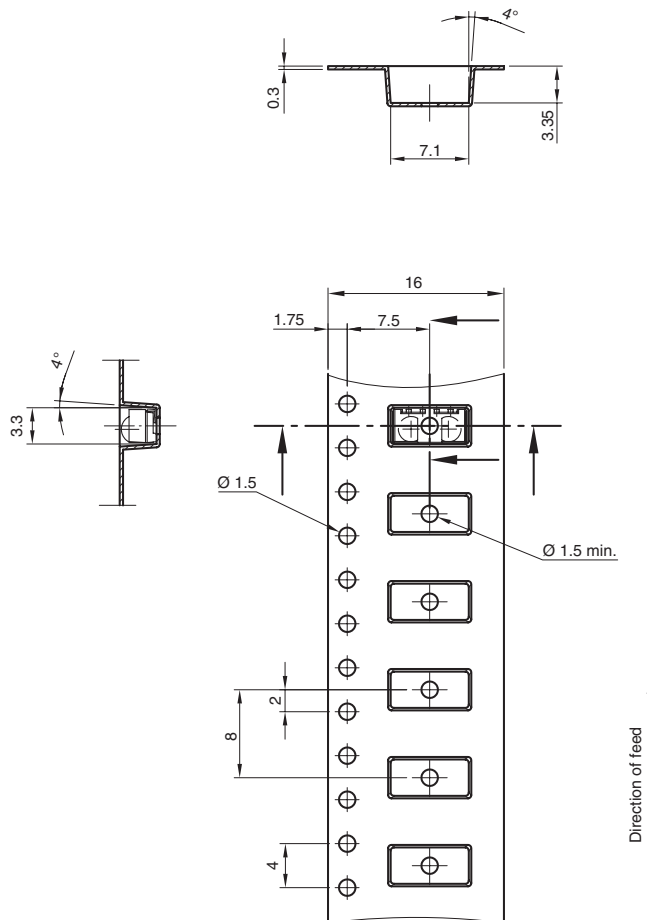
VISHAY LEAD (Pb)-FREE REFLOW SOLDER PROFILE

TAPING VERSION TSOP..TT Dimensions in millimeters

Drawing-No.: 9.700-5338.01-4
Issue: 3; 09.06.09
21578

technical drawings
according to DIN
specifications

TSOP75D25

Vishay Semiconductors

IR Receiver Modules for 3D
Synchronization Signals



TAPING VERSION TSOP..TR Dimensions in millimeters

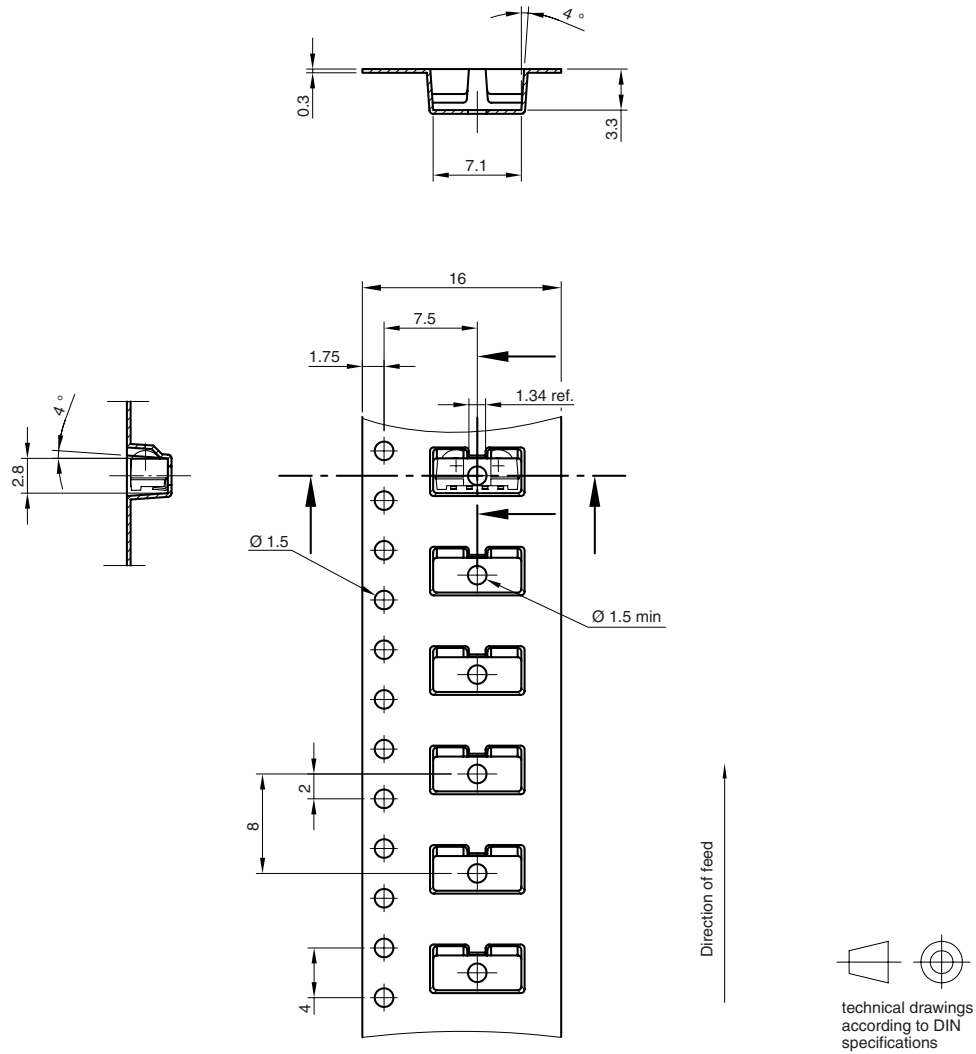

Drawing-No.: 9.700-5337.01-4
Issue: 1; 16.10.08
21577

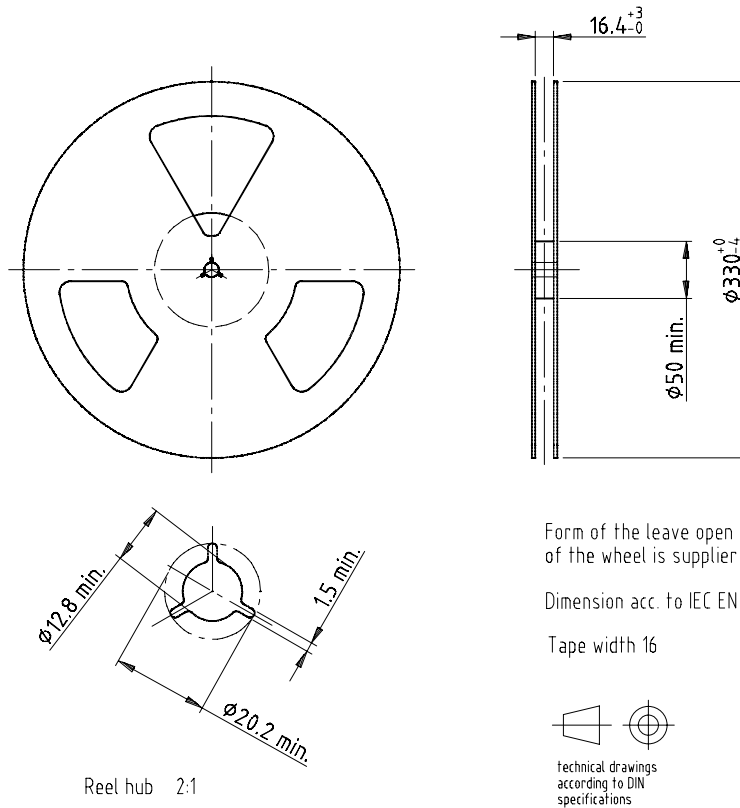
REEL DIMENSIONS in millimeters

Reel hub 2:1

Drawing refers to following types: Reel for blister carrier tape Version B

Drawing-No.: 9.800-5052.V2-4

Issue: 1; 07.05.02

16734

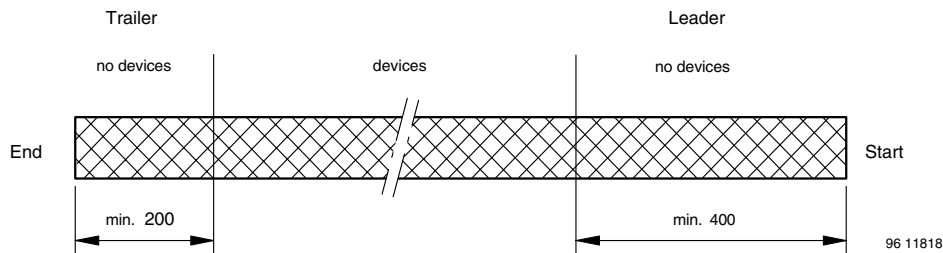
LEADER AND TRAILER Dimensions in millimeters

COVER TAPE PEEL STRENGTH

According to DIN EN 60286-3

0.1 N to 1.3 N

 300 mm/min. \pm 10 mm/min.

165° to 180° peel angle

LABEL
Standard bar code labels for finished goods

The standard bar code labels are product labels and used for identification of goods. The finished goods are packed in final packing area. The standard packing units are labeled with standard bar code labels before transported as finished goods to warehouses. The labels are on each packing unit and contain Vishay Semiconductor GmbH specific data.

VISHAY SEMICONDUCTOR GmbH STANDARD BAR CODE PRODUCT LABEL (finished goods)		
PLAIN WRITTING	ABBREVIATION	LENGTH
Item-description	-	18
Item-number	INO	8
Selection-code	SEL	3
LOT-/serial-number	BATCH	10
Data-code	COD	3 (YWW)
Plant-code	PTC	2
Quantity	QTY	8
Accepted by	ACC	-
Packed by	PCK	-
Mixed code indicator	MIXED CODE	-
Origin	xxxxxxx+	Company logo
LONG BAR CODE TOP	TYPE	LENGTH
Item-number	N	8
Plant-code	N	2
Sequence-number	X	3
Quantity	N	8
Total length	-	21
SHORT BAR CODE BOTTOM	TYPE	LENGTH
Selection-code	X	3
Data-code	N	3
Batch-number	X	10
Filter	-	1
Total length	-	17

DRY PACKING

The reel is packed in an anti-humidity bag to protect the devices from absorbing moisture during transportation and storage.

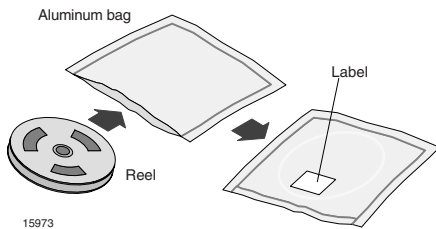

In case of moisture absorption, the devices will recover to the former condition by drying under the following condition:
 192 h at 40 °C + 5 °C/- 0 °C and < 5 % RH (dry air/nitrogen) or
 96 h at 60 °C + 5 °C and < 5 % RH for all device containers or
 24 h at 125 °C + 5 °C not suitable for reel or tubes.
 An EIA JEDEC standard JESD22-A112 level 4 label is included on all dry bags.

FINAL PACKING

The sealed reel is packed into a cardboard box. A secondary cardboard box is used for shipping purposes.

RECOMMENDED METHOD OF STORAGE

Dry box storage is recommended as soon as the aluminum bag has been opened to prevent moisture absorption. The following conditions should be observed, if dry boxes are not available:

- Storage temperature 10 °C to 30 °C
- Storage humidity ≤ 60 % RH max.

After more than 72 h under these conditions moisture content will be too high for reflow soldering.

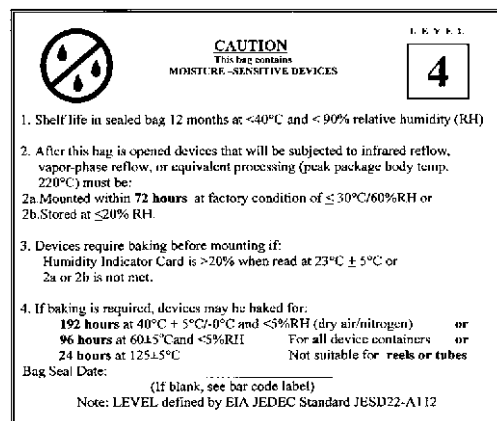

Example of JESD22-A112 level 4 label



ESD PRECAUTION

Proper storage and handling procedures should be followed to prevent ESD damage to the devices especially when they are removed from the antistatic shielding bag. Electro-static sensitive devices warning labels are on the packaging.

**VISHAY SEMICONDUCTORS STANDARD
BAR CODE LABELS**

The Vishay Semiconductors standard bar code labels are printed at final packing areas. The labels are on each packing unit and contain Vishay Semiconductors specific data.



16962



Disclaimer

All product specifications and data are subject to change without notice.

Vishay Intertechnology, Inc., its affiliates, agents, and employees, and all persons acting on its or their behalf (collectively, "Vishay"), disclaim any and all liability for any errors, inaccuracies or incompleteness contained herein or in any other disclosure relating to any product.

Vishay disclaims any and all liability arising out of the use or application of any product described herein or of any information provided herein to the maximum extent permitted by law. The product specifications do not expand or otherwise modify Vishay's terms and conditions of purchase, including but not limited to the warranty expressed therein, which apply to these products.

No license, express or implied, by estoppel or otherwise, to any intellectual property rights is granted by this document or by any conduct of Vishay.

The products shown herein are not designed for use in medical, life-saving, or life-sustaining applications unless otherwise expressly indicated. Customers using or selling Vishay products not expressly indicated for use in such applications do so entirely at their own risk and agree to fully indemnify Vishay for any damages arising or resulting from such use or sale. Please contact authorized Vishay personnel to obtain written terms and conditions regarding products designed for such applications.

Product names and markings noted herein may be trademarks of their respective owners.